

SECTION 24 LAYER WATERING PRICING

IN THIS CATALOG SECTION

PAGE NUMBER	CONTENTS
24-02	Regulators
24-03	Intakes / Hose / End Assemblies / Flush Kits
24-04	Standpipes
24-05	Header Kits / Lead In Kits / Air Releases
24-06	Filter Kits / Water Meters / Medicators / Cleaner & Solutions
24-07	Layer Pipe Kits - Round Pipe
24-08	Order Information for Cages with Angled Tops
24-09	Layer Pipe Kits - Square Pipe (Small)
24-10	Layer Pipe Kits - Square Pipe (Large)
24-11 thru 24-13	Drinker Flow Charts
24-14	Drinkers / Miscellaneous Parts / Replacement Standpipe Parts
24-15	Competitor Changeover & Replacement items
24-16	Pipe & Connectors / PVC Fittings
24-17	VR201 Regulator
24-18	VR204 Regulator
24-19	VR205 Regulator / VR209 Regulator
24-20 thru 24-21	Regulator Repair Parts
24-22	Filter Kit Repair Parts

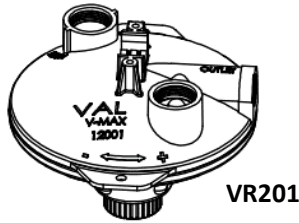

VR201

REGULATORS

V-MAX Regulator Ordering Instructions

1. Order the regulator.
2. Order desired bracket
3. Order the desired intake.
4. Order the desired standpipe.
5. Order the intake hose.

(3/4" for flush intake, 3/8" for old style intake.)

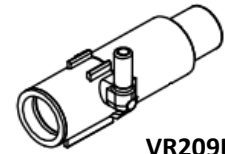

VR209P

V-MAX VR201 FLOOR REGULATOR KIT (requires 1 standpipe)

CATALOG #	ITEM DESCRIPTION	SHIP WEIGHT		LIST PRICE
		LBS.	KG.	
VR201K	Cage Regulator Kit	1.85	0.84	

V-MAX VR201 FLOOR REGULATOR KIT

VRP29	Cage Regulator Support Bracket	0.39	0.18	
610067	Cage Regulator Support Bracket	1.25	0.57	

V-MAX VR204 SLOPE REGULATOR (req. 2 standpipe - 1 must be 'K' designation)

CATALOG #	ITEM DESCRIPTION	SHIP WEIGHT		LIST PRICE
		LBS.	KG.	
VR204KA	Cage Slope Regulator Kit - Aluminum	1.87	0.85	
VR204KC	Cage Slope Regulator Kit - Conduit	1.85	0.84	

VR209 SLOPE REGULATOR

CATALOG #	ITEM DESCRIPTION	SHIP WEIGHT		LIST PRICE
		LBS.	KG.	
VR211-18	Slope Regulator Kit With 18" Standpipe & Coupler (Conduit)	0.35	0.2	
VR211-24	Slope Regulator Kit With 24" Standpipe & Coupler (Conduit)	0.36	0.2	
VR211-30	Slope Regulator Kit With 30" Standpipe & Coupler (Conduit)	0.38	0.2	
VR209P	Slope Regulator Only - Automatic Flush Thru	0.18	0.1	
VR209S	Air Release with "L" Stem	0.11	0.1	
820513	Air Release with Side Exit Stem	0.10	0.0	
820515	Slope Regulator Only - with Side Exit Stem	0.17	0.1	
820516	Slope Regulator Only - with Side Stem Plug	0.17	0.1	
VRP90	Slope Regulator - Left Kit for VR209	0.11	0.0	

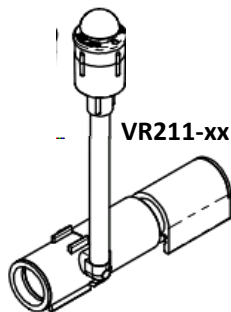

VR211-xx

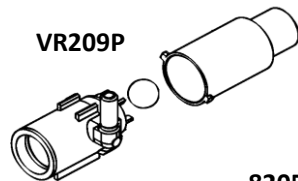

VR209P

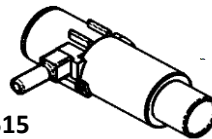

820515
820513 (no SS Ball)

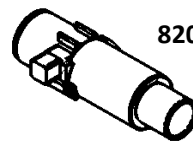

820516

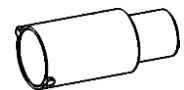

VRP90

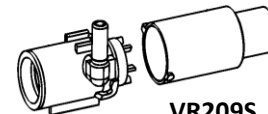

VR209S

VR205 HIGH PRESSURE REGULATOR

CATALOG #	ITEM DESCRIPTION	SHIP WEIGHT		LIST PRICE
		LBS.	KG.	
VR205	High Pressure Regulator Kit - No Gauges	2.16	0.98	
VR205-1	High Pressure Regulator Kit - 1 Oil Filled Pressure Gauge	2.65	1.20	
VR205-2	High Pressure Regulator Kit - 2 Oil Filled Pressure Gauges	3.14	1.42	

Maximum Incoming Pressure: 100 PSI

Pressure Range: 25 PSI Minimum

INDIVIDUAL REGULATOR

CATALOG #	ITEM DESCRIPTION	SHIP WEIGHT		LIST PRICE
		LBS.	KG.	
12001	V-MAX Regulator only for VR201K	1.54	0.70	
12002	V-MAX Regulator only for VR202K	1.48	0.67	
12003	V-MAX Regulator only for VR203K	1.60	0.73	
12004	V-MAX Regulator only for VR204K	1.60	0.73	

<p align="center">STANDARD</p> <p align="center">Incoming Pressure 15-40 PSI</p> <p align="center">Pressure Range 0-1.3 PSI or 0-36" Water Column</p> <p align="center">Note: Head of house regulator pressure not to be set below 25psi.</p>	<p>INTAKE KITS</p> 	<p align="center">LOW PRESSURE</p> <p align="center">Incoming Pressure 4-15 PSI</p> <p align="center">Pressure Range 0-1.3 PSI or 0-36" Water Column</p>
--	--	---

CATALOG #	ITEM DESCRIPTION	SHIP WEIGHT		LIST PRICE
		LBS.	KG.	
RFV160K	Inlet Kit, Flushing, Shut Off (incl. (2) PMTT6, VRP66, VRP67S, (2) PMHC3-4)	0.62	0.28	
RFV160LK	Inlet Kit, Flushing, Shut off, Low pressure (incl. same parts as RFV160K)	0.66	0.30	
VRP09K	Inlet Kit, Shut off (incl. (2) VRP45 & (2) VRP375)	0.16	0.07	
VRP09LK	Inlet Kit, Shut off, low pressure (incl. (2) VRP45 & (2) VRP375)	0.16	0.07	

INDIVIDUAL INTAKE				
RFV160	Regulator Flushing Intake only	0.41	0.18	
RFV160L	Regulator Flushing Intake only - Low Pressure	0.41	0.18	
VRP09	Shutoff Intake only	0.13	0.06	
VRP09L	Shutoff Intake only - Low Pressure	0.09	0.04	
VRP30F	Shutoff Intake with Flex Standpipe Connection	0.12	0.05	

HOSE				
VRP79-Q300	PVC Yellow Regulator drop HOSE, 3/4" ID (Unit of measure: 300 Foot Roll) For use with new style flush intake. (RFV160)	66.20	30.03	
VRP79	PVC Yellow Regulator drop HOSE, 3/4" ID (Unit of measure: Per foot) For use with new style flush intake. (RFV160)	0.18	0.08	
VRP48-Q500	PVC Yellow Regulator Drop Hose, 3/8" (Unit of measure: 500 Foot Roll) For use with old style intake. (VRP09)	39.60	17.96	
VRP48	PVC Yellow Regulator Drop Hose, 3/8" (Unit of measure: per foot) For use with old style intake. (VRP09)	0.08	0.04	

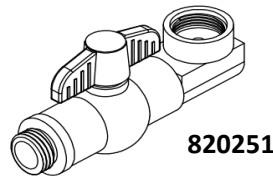

END ASSEMBLIES (requires 1 standpipe)				
CATALOG #	ITEM DESCRIPTION	SHIP WEIGHT		LIST PRICE
		LBS.	KG.	
820251	End Assembly Kit, US standard thread, Garden Hose Adapter	0.37	0.17	
820252	End Assembly Kit, Metric thread, Garden Hose Adapter	0.39	0.18	

FLUSH KITS FOR CAGES				
VF100B	With 12" Standpipe - Lower Tiers	10.28	4.66	
VF100T	With 12" Standpipe - Top Tier Only	2.36	1.1	
VF100TM	With 12" Standpipe - Top Tier Only (Metric)	2.34	1.06	
VF100-18B	With 18" Standpipe - Lower Tiers	10.40	4.72	
VF100-18T	With 18" Standpipe - Top Tier Only	2.48	1.1	
VF100-18TM	With 18" Standpipe - Top Tier Only (Metric)	2.45	1.11	
VF100-24B	With 24" Standpipe - Lower Tiers	3.60	1.63	
VF100-24T	With 24" Standpipe - Top Tier Only	2.15	1.0	
VF100-24TM	With 24" Standpipe - Top Tier Only (Metric)	2.57	1.17	
VF100SB	For Stacked Cages - With 24" Standpipe - Lower Tiers	8.00	3.63	
VF100SBM	For Stacked Cages - With 24" Standpipe - Lower Tiers (Metric)	2.35	1.07	

FLEX STANDPIPE

Foldover Standpipes		SHIP WEIGHT		LIST PRICE
		LBS.	KG.	
CATALOG #	ITEM DESCRIPTION			
VSP18FO	FLEX SP ASSY, 18", FOLD OVER	0.44	0.20	
VSP24FO	FLEX SP ASSY, 24", FOLD OVER	0.50	0.23	
VSP30FO	FLEX SP ASSY, 30", FOLD OVER	0.47	0.21	
Shutoff Standpipes				
VSP18FS	FLEX SP ASSY, 18", SHUTOFF	0.36	0.16	
VSP24FS	FLEX SP ASSY, 24", SHUTOFF	0.49	0.22	
VSP30FS	FLEX SP ASSY, 30", SHUTOFF	0.56	0.25	
1/2" NPT Standpipes				
VSP18FK	FLEX SP ASSY, 18", INTAKE	0.35	0.16	
VSP24FK	FLEX SP ASSY, 24", INTAKE	0.44	0.20	
VSP30FK	FLEX SP ASSY, 30", INTAKE	0.46	0.21	



RIGID STANDPIPE

Foldover Standpipes		SHIP WEIGHT		LIST PRICE
		LBS.	KG.	
CATALOG #	ITEM DESCRIPTION			
VSP12RO	RIGID SP ASSY, 12", FOLD OVER	0.22	0.10	
VSP18RO	RIGID SP ASSY, 18", FOLD OVER	0.33	0.15	
VSP24RO	RIGID SP ASSY, 24", FOLD OVER	0.37	0.17	
VSP30RO	RIGID SP ASSY, 30", FOLD OVER	0.40	0.18	
VSP36RO	RIGID SP ASSY, 36", FOLD OVER	0.38	0.17	
Shutoff Standpipes				
VSP12RS	RIGID SP ASSY, 12", SHUTOFF	0.30	0.14	
VSP18RS	RIGID SP ASSY, 18", SHUTOFF	0.32	0.15	
VSP24RS	RIGID SP ASSY, 24", SHUTOFF	0.40	0.18	
VSP30RS	RIGID SP ASSY, 30", SHUTOFF	0.32	0.14	
VSP36RS	RIGID SP ASSY, 36", SHUTOFF	0.36	0.16	
1/2" NPT Standpipes				
VSP12RR	RIGID SP ASSY, 12", 1/2" NPT	0.24	0.11	
VSP18RR	RIGID SP ASSY, 18", 1/2" NPT	0.29	0.13	
VSP24RR	RIGID SP ASSY, 24", 1/2" NPT	0.41	0.19	
VSP30RR	RIGID SP ASSY, 30", 1/2" NPT	0.39	0.18	
VSP36RR	RIGID SP ASSY, 36", 1/2" NPT	0.44	0.20	
Intake Standpipes				
VSP12RK	RIGID SP ASSY, 12", INTAKE	0.21	0.10	
VSP18RK	RIGID SP ASSY, 18", INTAKE	0.25	0.11	
VSP24RK	RIGID SP ASSY, 24", INTAKE	0.29	0.13	
VSP30RK	RIGID SP ASSY, 30", INTAKE	0.33	0.15	
VSP36RK	RIGID SP ASSY, 36", INTAKE	0.37	0.17	

BRUSHES FOR STANDPIPES

VB151	Bottle Brush for Rigid Standpipe	0.11	0.05	
VB151F	Bottle Brush for Flex Standpipe	0.11	0.05	

LAYER WATERING OPTIONS

HEADER KITS

CATALOG #	ITEM DESCRIPTION	SHIP WEIGHT		LIST PRICE
		LBS.	KG.	
VH100B	Cage Header Kit - Lower Tiers	1.88	0.85	
VH100T	Cage Header Kit - Top Tier Only	1.79	0.81	
VH100SB	Cage Header Kit - for Stacked Cage Lower Tiers	1.40	0.64	
VH100ST	Cage Header Kit - for Stacked Cage Top Tier Only	1.55	0.70	

LEAD-IN KITS

CATALOG #	ITEM DESCRIPTION	SHIP WEIGHT		LIST PRICE
		LBS.	KG.	
VL100	Lead-In Kit From Filter to First Row	8.46	3.84	
VL200	Lead-In Kit From One Row to Next Row	4.03	1.83	

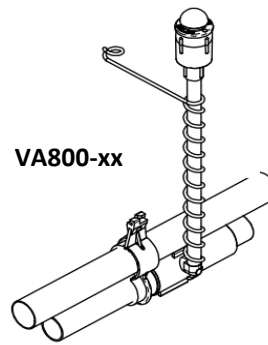

AIR RELEASES

CATALOG #	ITEM DESCRIPTION	SHIP WEIGHT		LIST PRICE
		LBS.	KG.	
VA800-24	Air Release With Auto Shutoff & 24" Flex Standpipe - Conduit	0.71	0.32	
VA800-30	Air Release With Auto Shutoff & 30" Flex Standpipe - Conduit	0.74	0.33	
VR209S	Left Body Only - for Air Release & Slope Regulator	0.11	0.05	

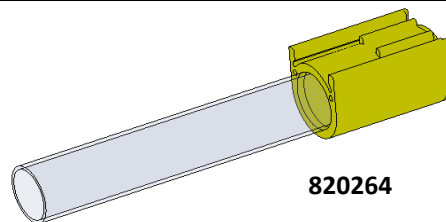

VIEWPORT

CATALOG #	ITEM DESCRIPTION	SHIP WEIGHT		LIST PRICE
		LBS.	KG.	
820624	Viewport 6" Long - 3/4" Clear PVC with VC145 Coupler	0.12	0.05	

LAYER WATERING OPTIONS

FILTER KIT/BACKFLUSH		SHIP WEIGHT		LIST PRICE
		LBS.	KG.	
CATALOG #	ITEM DESCRIPTION			
VF122	Filter Kit/Backflush Hookup	9.25	4.20	
VF122L	Filter Kit/Backflush Hookup - Low Pressure	9.03	4.10	
VF122-H	Filter Kit - Without Hookup or Gauges(30 Micron Filter)	6.95	3.15	
VF122L-H	Filter Kit - W/O Hookup or Gauges - Low Pressure (50 Micron Filter)	6.74	3.06	

WATER METERS <i>(kits includes [2] VT132 -3/4" PVC female adapter S X thread)</i>		SHIP WEIGHT		LIST PRICE
		LBS.	KG.	
CATALOG #	ITEM DESCRIPTION			
820370	WATER METER KIT , GAL, LOCAL, 5/8"X3/4", Brass Body, Line Size 3/4"	8.00	3.6	
820371	WATER METER KIT , GAL, DIGITAL, 5/8"X3/4", Brass Body, Line Size 3/4"	8.00	3.6	
820372	WATER METER KIT , MET, LOCAL, 5/8"X3/4", Brass Body, Line Size 3/4"	8.00	3.6	
820373	WATER METER KIT , MET, DIGITAL, 5/8"X3/4", Brass Body, Line Size 3/4"	8.00	3.6	
820374	WATER METER KIT , GAL, LOCAL, 5/8" X 3/4", Plastic Body, Line Size 3/4"	8.00	2.7	
820375	WATER METER KIT , GAL, DIGITAL, 5/8" X 3/4", Plastic Body, Line Size 3/4"	3.10	2.7	
820376	WATER METER KIT , MET, LOCAL, 5/8" X 3/4", Plastic Body, Line Size 3/4"	2.85	2.7	
820377	WATER METER KIT , MET, DIGITAL, 5/8" X 3/4", Plastic Body, Line Size 3/4"	8.00	2.7	
820284	PVC Adapter, 1" X 3/4", slip x slip, schedule 40	0.10	0.05	
VT100	3/4" PVC Tee S X S X S	0.01	0.00	
VT102	3/4" PVC 90 ELL S X S	0.07	0.04	
VT132	3/4" PVC Female Adapter S X Thread	0.05	0.02	
VV801	3/4" Ball Valve	0.26	0.11	
VX127	3/4" Union S X S	0.16	0.07	

MEDICATOR		SHIP WEIGHT		LIST PRICE
		LBS.	KG.	
CATALOG #	ITEM DESCRIPTION			
VM501	Dosatron Medicator Kit (D25RE2) - Dilution Range 1:500 to 1:50 (.2% to 2%)	3.41	1.55	
820341	Dosatron Medicator Kit (D25RE5) - Dilution Range 1:100 to 1:20 (1% to 5%)	4.00	1.81	
VM507	Hook-Up Kit for Medicator Dosatron	1.46	0.66	
VM504	Repair Kit for VM500 Dosatron Medicator (D25RE2)	44.00	19.96	

Medicator can be used in high or low pressure systems from 4.3-85 PSI (.3-5.86 Bar).

CLEANERS / SOLUTIONS		SHIP WEIGHT		LIST PRICE
		LBS.	KG.	
CATALOG #	ITEM DESCRIPTION			
PM10TS	10TS Water Treatment System	25.00	11.34	
PMCPABU1	Water Treatment Solution - 5 Gallon (PARAFOS)	50.00	22.68	



LAYER WATERING PIPE KITS - ROUND PIPE w/ J-Lock Saddles (Drinkers not included.)

- For installation on cages with no angle, select catalog number without "-1" suffix (i.e., VP108).
 - For installation on cages with angled top, see next page for assistance in selecting "-1" catalog number
 - For installation on cages where the coupler needs to be installed on the other end of the pipe add suffix "-REVERSE"
- See page 24-08 with chart showing options.

			SADDLE TYPE					
			VL145 - 45° OPEN SADDLE		VL155 - 45° CLOSED SADDLE		VS146 STANDARD SADDLE	
NO. OF DRINKERS	DRINKER SPACING	PIPE LENGTH	CATALOG NUMBER	LIST PRICE	CATALOG NUMBER	LIST PRICE	CATALOG NUMBER	LIST PRICE
3	32"	8'	VP108-45O		VP108-45C		VP108	
			VP108-45O-1		VP108-45C-1		VP108-1	
3	36"	9'	VP109-45O		VP109-45C		VP109	
			VP109-45O-1		VP109-45C-1		VP109-1	
3	40"	10'	VP110-45O		VP110-45C		VP110	
			VP110-45O-1		VP110-45C-1		VP110-1	
4	24"	8'	VP113-45O		VP113-45C		VP113	
			VP113-45O-1		VP113-45C-1		VP113-1	
4	30"	10'	VP107-45O		VP107-45C		VP107	
			VP107-45O-1		VP107-45C-1		VP107-1	
5	23.6" 60cm	9.85' 3m	VP112-45O		VP112-45C		VP112	
			VP112-45O-1		VP112-45C-1		VP112-1	
5	24"	10'	VP106-45O		VP106-45C		VP106	
			VP106-45O-1		VP106-45C-1		VP106-1	
6	16"	8'	VP114-45O		VP114-45C		VP114	
			VP114-45O-1		VP114-45C-1		VP114-1	
6	18"	9'	VP104-45O		VP104-45C		VP104	
			VP104-45O-1		VP104-45C-1		VP104-1	
6	18.9" 48cm	9.45' 2.88m	VP111-45O		VP111-45C		VP111	
			VP111-45O-1		VP111-45C-1		VP111-1	
6	20"	10'	VP105-45O		VP105-45C		VP105	
			VP105-45O-1		VP105-45C-1		VP105-1	
7	16"	9.33'	VP103-45O		VP103-45C		VP103	
			VP103-45O-1		VP103-45C-1		VP103-1	
8	12"	8'	VP115-45O		VP115-45C		VP115	
			VP115-45O-1		VP115-45C-1		VP115-1	
8	15"	10'	VP102-45O		VP102-45C		VP102	
			VP102-45O-1		VP102-45C-1		VP102-1	
10	12"	10'	VP101-45O		VP101-45C		VP101	
			VP101-45O-1		VP101-45C-1		VP101-1	
12	10"	10'	VP100-45O		VP100-45C		VP100	
			VP100-45O-1		VP100-45C-1		VP100-1	
16	6"	8'	VP116-45O		VP116-45C		VP116	
			VP116-45O-1		VP116-45C-1		VP116-1	

Select the a model and quantity of drinkers (Page 24-14) to match the number of pipe kits / saddles ordered.

CUSTOM & NON-STOCKED PIPE KITS

Custom square pipe kits are available; call for availability. Note that orders for square pipe kits may not be cancelled after production commences. Not returns are permitted square pipe kits.

LAYER WATERING PIPE KITS - ROUND PIPE

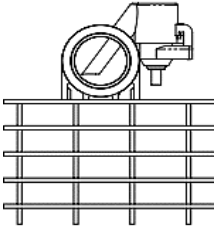
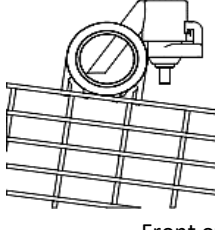
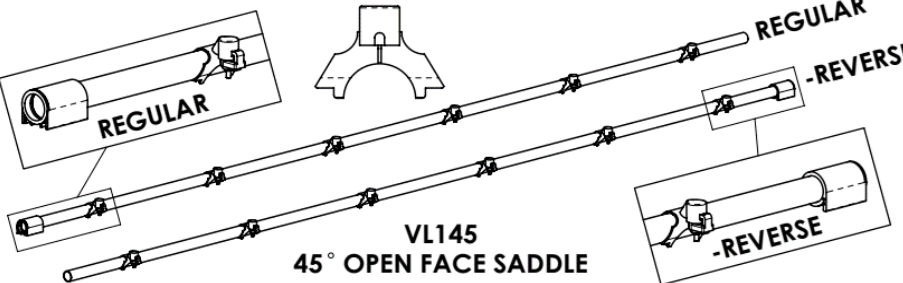
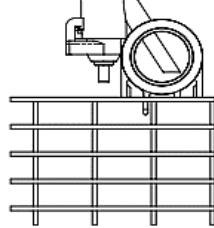
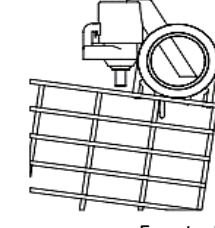
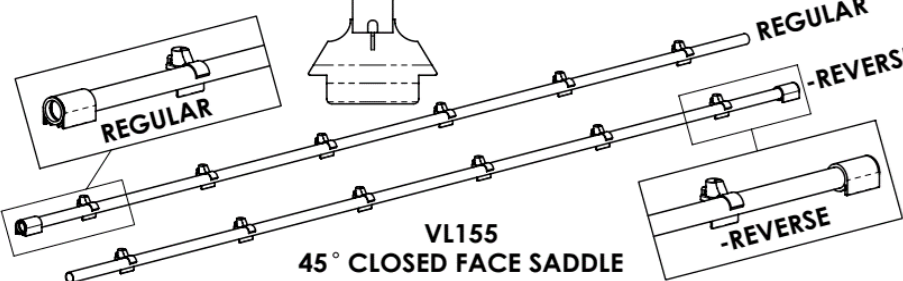
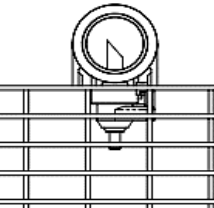
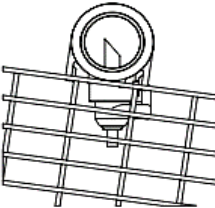
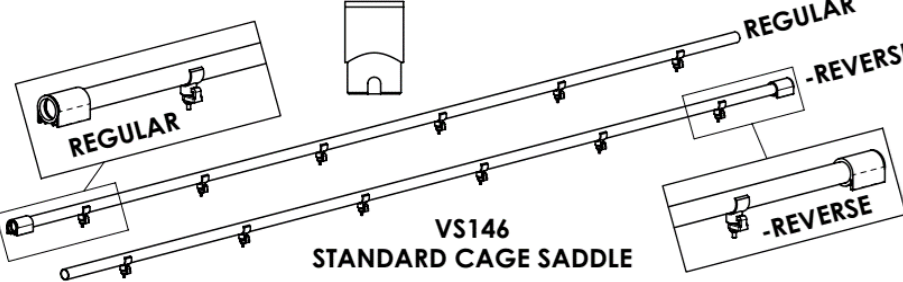
REGULAR BASE PIPE KIT CATALOG NUMBER CAGE SITS FLAT	METHOD 1 PIPE KIT CATALOG NUMBER WITH "-1" OR "SUFFIX" CAGE TILTS 8° DOWN TOWARDS TROUGH	SADDLE TYPE & ORIENTATION (add suffix "-REVERSE" for coupler to be installed on opposite end of pipe.)
	 <p>Front of Cage --></p>	 <p>VL145 45° OPEN FACE SADDLE</p>
	 <p>Front of Cage --></p>	 <p>VL155 45° CLOSED FACE SADDLE</p>
	 <p>Front of Cage --></p>	 <p>VS146 STANDARD CAGE SADDLE</p>
<p align="center">NOTE Custom or Reverse Pipe Kits Cannot be Returned</p>		

LAYER WATERING PIPE KITS - ROUND PIPE

- For installation on cages with no angle, select catalog number without "-1" suffix (i.e., VP108).
- For installation on cages with angled top, select catalog number with suffix "-1" (i.e., VP108-1)
- For installation on cages where the coupler needs to be installed on the other end of the pipe, add suffix "-REVERSE" to the end of the pipe kit number (i.e., VP108-REVERSE or VP108-1-REVERSE)

Layer Watering Pipe Kits

PIPE KITS WITH J-LOCK SADDLES

Order the desired number of PVC pipes with glued VS205 saddles & 820271 square pipe coupler. Drinkers not included.

			Pipe Kits	
NUMBER OF DRINKERS	DRINKER SPACING	PIPE LENGTH	CATALOG NUMBER	LIST PRICE
3	32"	8'	VP408	
3	36"	9'	VP409	
3	40"	10'	VP410	
4	24"	8'	VP413	
4	30"	10'	VP407	
5	23.6" 60cm	9.85' 3m	VP412	
5	24"	10'	VP406	
6	16"	8'	VP414	
6	18"	9'	VP404	
6	18.9" 48cm	9.45' 2.88m	VP411	
6	20"	10'	VP405	
7	16"	9.33'	VP403	
8	12"	8'	VP415	
8	15"	10'	VP402	
10	12"	10'	VP401	
12	10"	10'	VP400	
16	6"	8'	VP416	

Select the a model and quantity of drinkers (Page 24-14) to match the pipe kit(s) chosen.

CUSTOM & NON-STOCKED PIPE KITS

Custom square pipe kits are available; call for availability. Note that orders for square pipe kits may not be cancelled after production commences. Not returns are permitted square pipe kits.

**LAYER WATERING PIPE KITS
 LARGE 1.1" SQUARE PIPE**

PIPE KITS WITH J-LOCK SADDLES

Order the desired number of PVC pipes with glued VS405 saddles & 820270 square pipe coupler. (Drinkers not included.)

NUMBER OF DRINKERS	DRINKER SPACING	PIPE LENGTH	DRINKER TYPE	
			CATALOG NUMBER	LIST PRICE
3	32"	8'	VP608	
3	36"	9'	VP609	
3	40"	10'	VP610	
4	24"	8'	VP613	
4	30"	10'	VP607	
5	23.6" 60cm	9.85' 3m	VP612	
5	24"	10'	VP606	
6	16"	8'	VP614	
6	18"	9'	VP604	
6	18.9" 48cm	9.45' 2.88m	VP611	
6	20"	10'	VP605	
7	16"	9.33'	VP603	
8	12"	8'	VP615	
8	15"	10'	VP602	
10	12"	10'	VP601	
12	10"	10'	VP600	
16	6"	8'	VP616	

Select the a model and quantity of drinkers (page 24-14) to match the pipe kit(s) chosen.

CUSTOM & NON-STOCKED PIPE KITS

Custom square pipe kits are available; call for availability. Note that orders for square pipe kits may not be cancelled after production commences. Not returns are permitted square pipe kits.

Layer Chicken Drinker Options - Flow Rates

Broiler / Layer Drinker Flow Rates vs. Inches [Centimeters] of Water

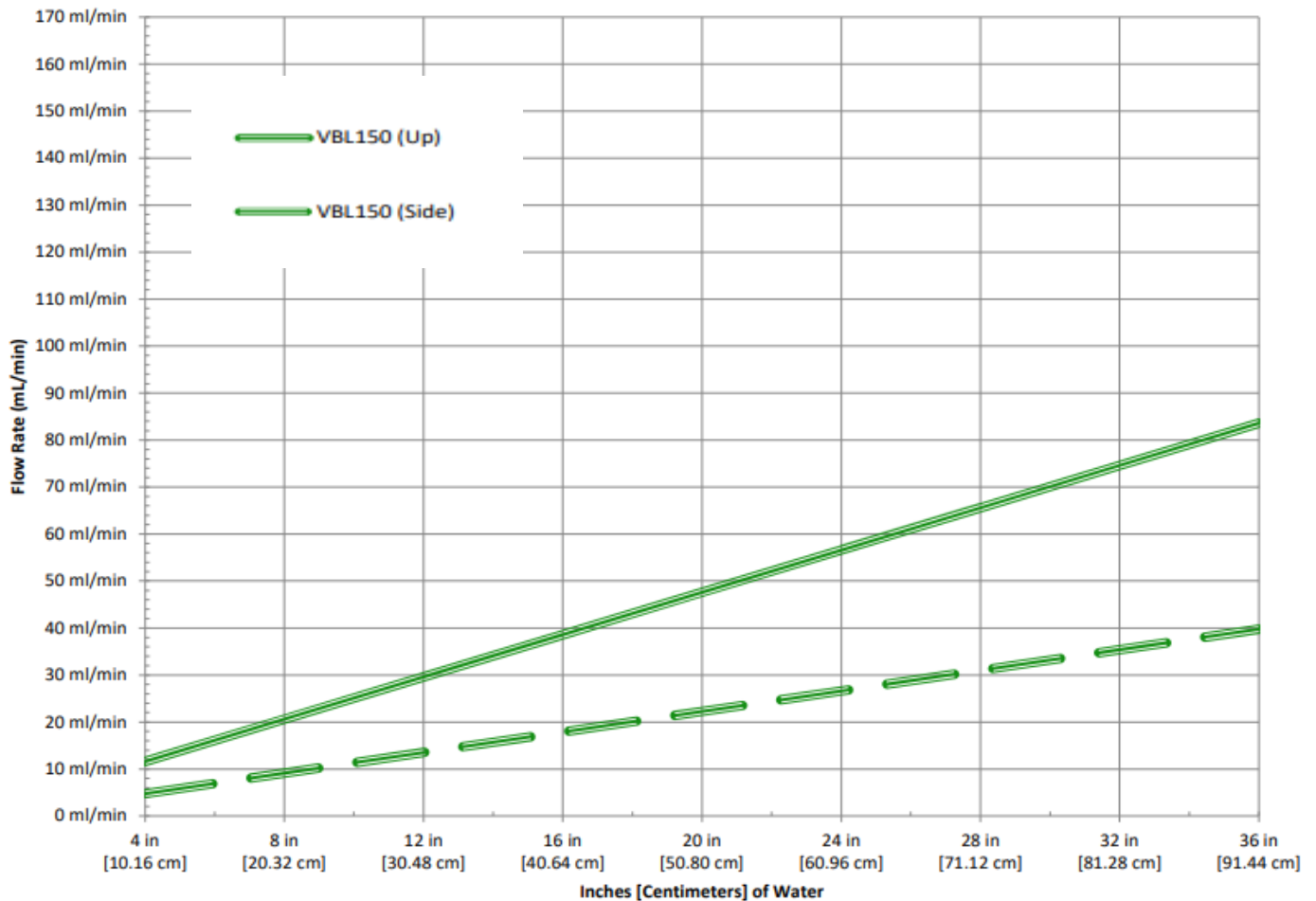

Layer Chicken Drinker Options - Flow Rates

Aqua-V Series Flow Rates vs. Inches [Centimeters] of Water

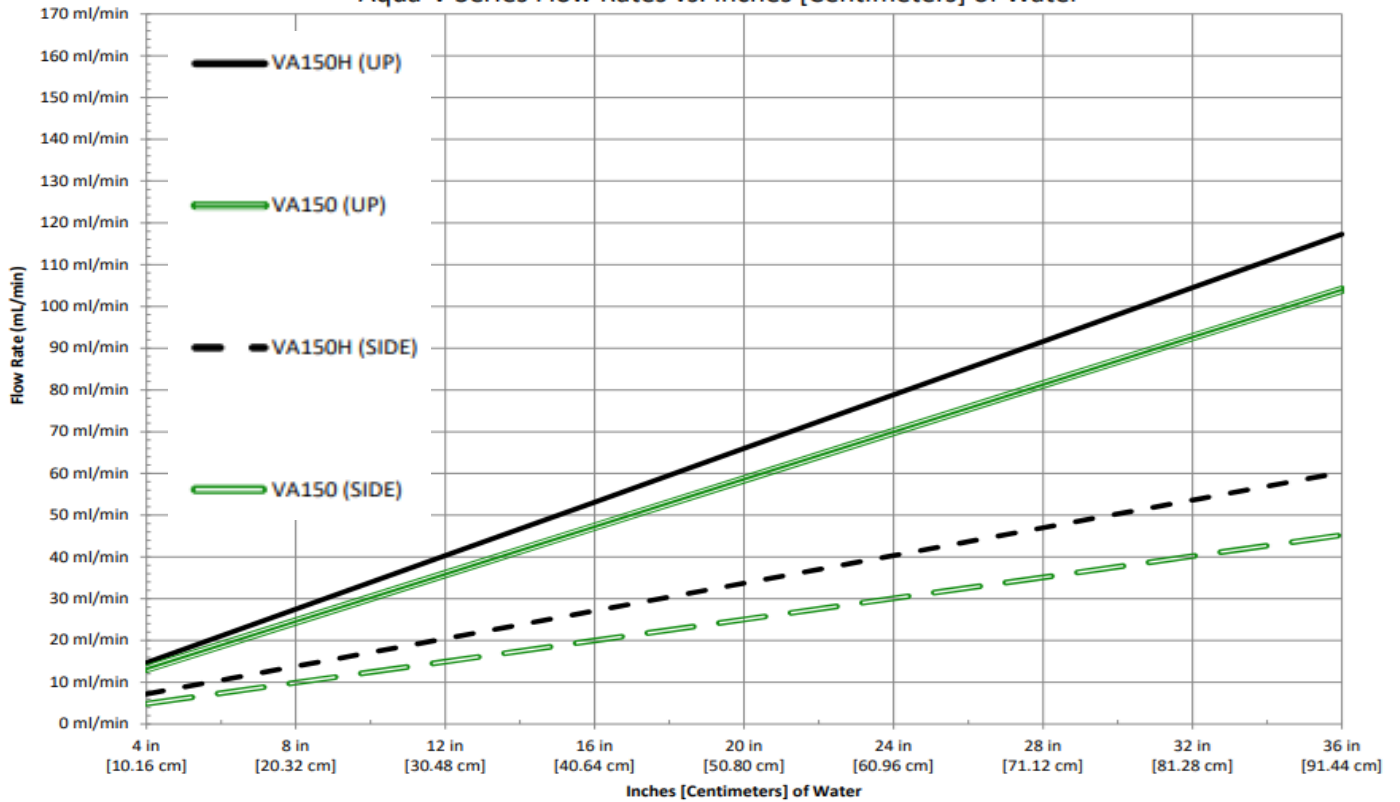

Aqua-V PFA Series Flow Rates vs. Inches [Centimeters] of Water

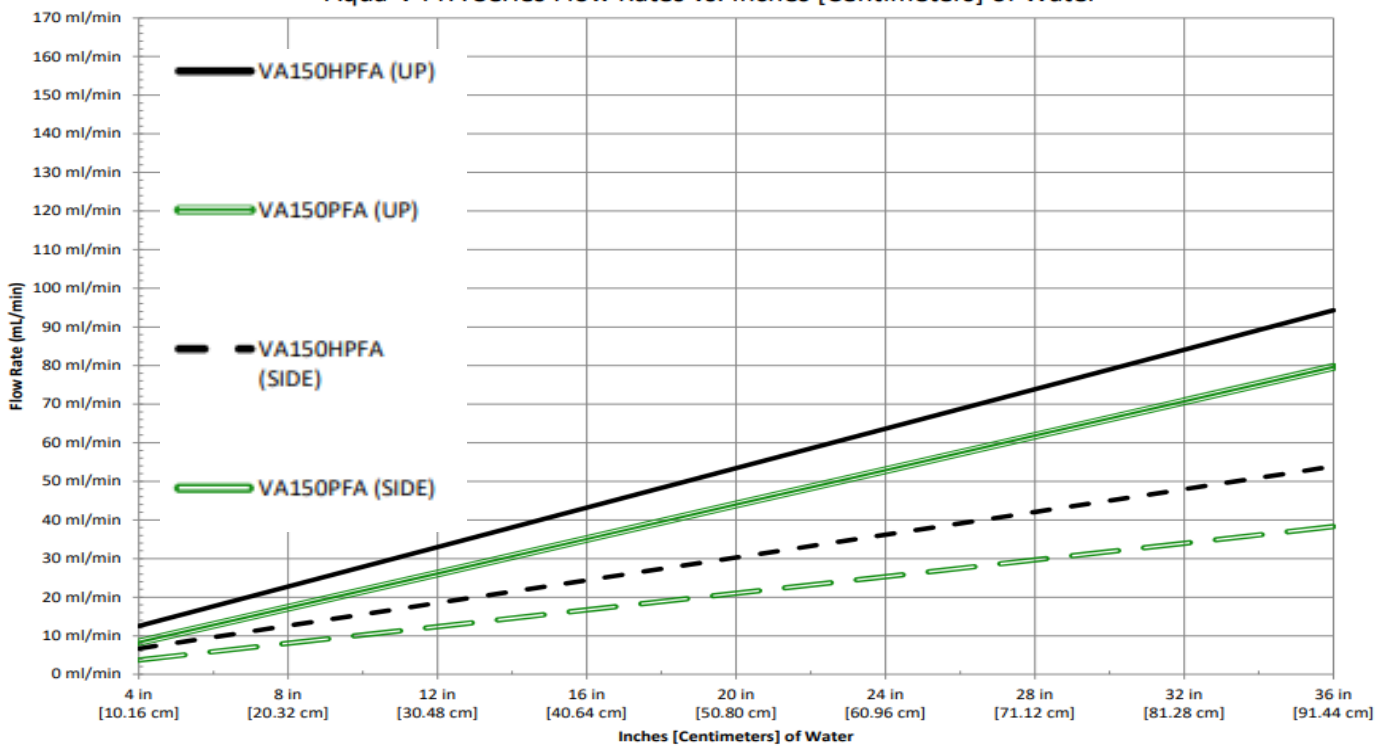

Layer Chicken Drinker Options - Flow Rates

Roaster Series Flow Rates vs. Inches [Centimeters] of Water

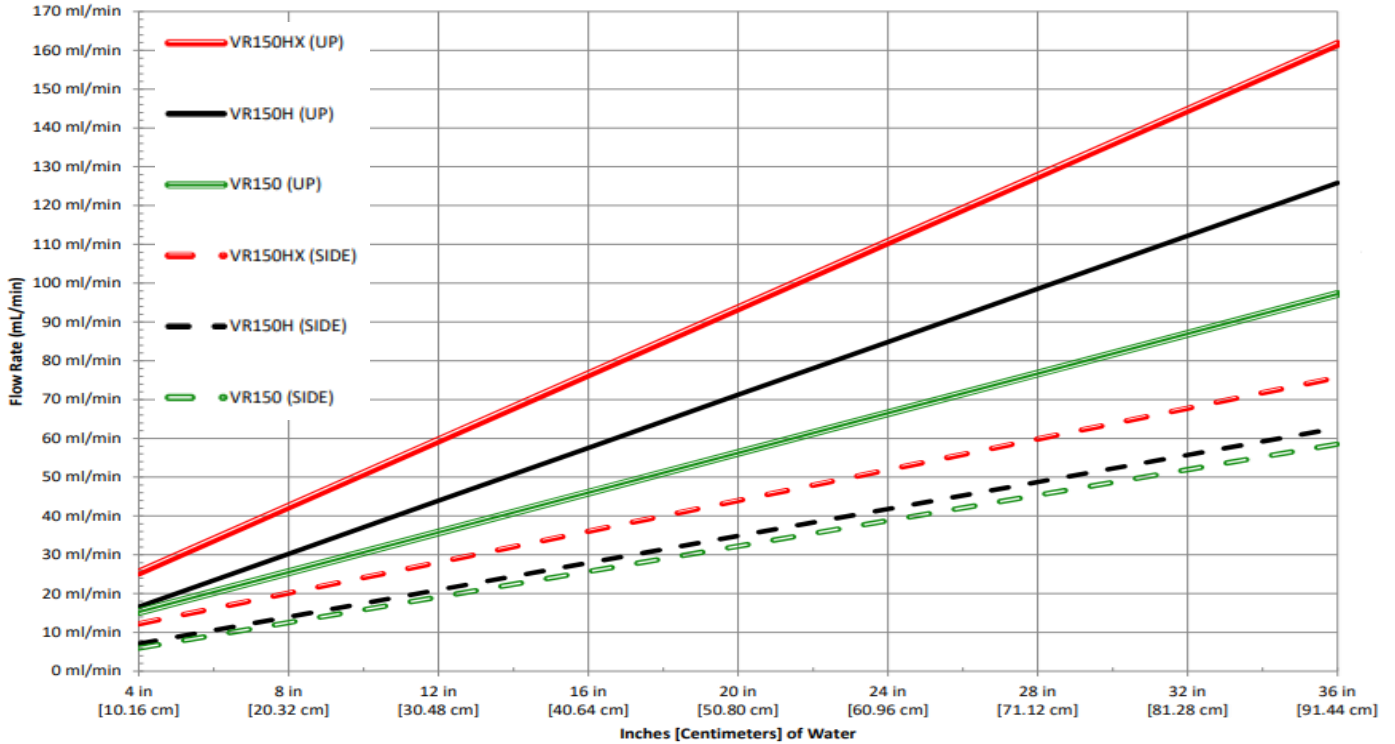

Roaster PFA Flow Rates vs. Inches [Centimeters] of Water

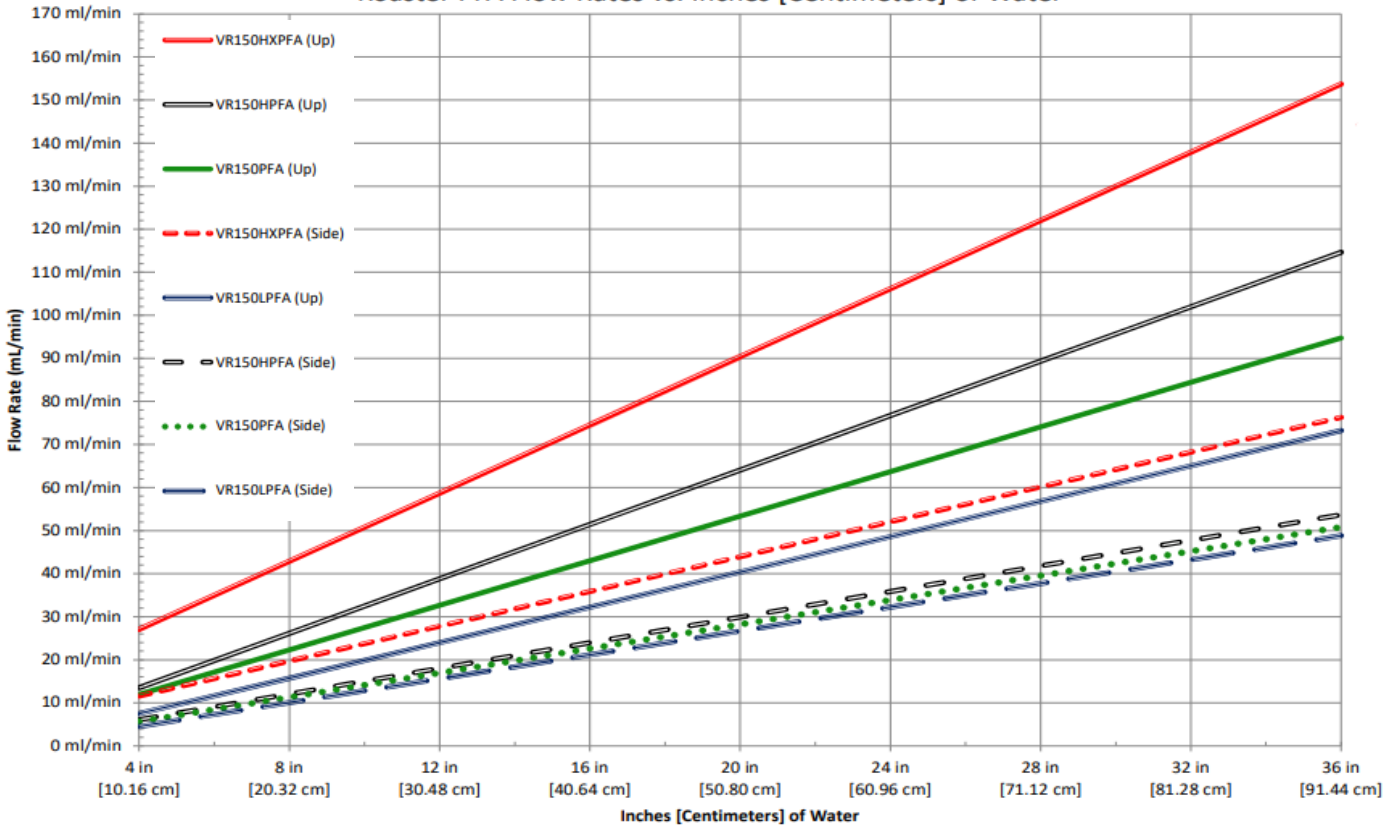

LAYER WATERING OPTIONS

Drinkers		SHIP WEIGHT		LIST PRICE
		LBS.	KG.	
CATALOG #	ITEM DESCRIPTION			
VD150	Dummy Drinker	0.01	0.00	
VBL150	Layer Drinker	0.02	0.01	
VA150	Aqua-V Drinker	0.02	0.01	
VA150H	Aqua-V Drinker High Flow	0.02	0.01	
VA150PFA	Aqua-V Drinker High Flow PFA	0.02	0.01	
VA150HPFA	Aqua-V Drinker High Flow PFA	0.02	0.01	
VR150	Roaster Drinker	0.02	0.01	
VR150H	Roaster Drinker High Flow	0.02	0.01	
VR150PFA	Roaster Drinker	0.02	0.01	
VR150HPFA	Roaster Drinker High Flow	0.02	0.01	

Box Quantity is 2000

Drinker Repair Parts

VAL-TOOL	Drinker Tool - New Style Universal	0.03	0.01	
VO140	O-Ring For Val Drinker Drinkers	0.00	0.00	
VS146	Saddle Standard (Replaces VS146C)	0.01	0.00	
VS146-Q500	Saddle Standard (Replaces VS146C) - Box of 500	5.60	2.54	

Miscellaneous Parts

VB130	Plastic Cage Bracket	0.02	0.01	
VS143	Pipe Support Bracket - Plastic With Clip	0.04	0.02	
VS144	3" Pipe Support Wire	0.07	0.03	
VS145	2" Pipe Support Wire	0.06	0.03	
VC147	Cage Clip	0.01	0.00	
VC149	Large Cage Clip	0.01	0.00	

Replacement Standpipe Parts

820295	Direct replacement standpipe TruSeal cap for flexible standpipes	0.05	0.02	
820611	Direct replacement standpipe TruSeal cap for rigid standpipes	0.06	0.03	
820348	TruSeal rigid standpipe kit. Includes cap and float ball	0.06	0.03	
820349	TruSeal flex standpipe kit. Includes cap and float ball	0.06	0.03	
VC025TS	TruSeal flex cap kit includes cap and glue on adapter	0.06	0.03	
VS130	Spring for 18" flex standpipe when using TruSeal Cap	0.17	0.07	
VS132	Spring for 24" flex standpipe when using TruSeal Cap	0.23	0.10	
VS133	Spring for 30" flex standpipe when using TruSeal Cap	0.28	0.13	
VS134	Spring for 36" flex standpipe when using TruSeal Cap	0.34	0.15	
VSP12RA	RIGID SP ASSY, 12", 1/2" NPT	0.15	0.07	
VSP18RA	RIGID SP ASSY, 18", 1/2" NPT	0.26	0.12	
VSP24RA	RIGID SP ASSY, 24", 1/2" NPT	0.30	0.14	
VSP30RA	RIGID SP ASSY, 30", 1/2" NPT	0.27	0.12	
VSP36RA	RIGID SP ASSY, 36", 1/2" NPT	0.32	0.14	
VSP24FY	FLEX SP ASSY, 24", Replacement [Flex Tube & TruSeal]	0.11	0.05	

LAYER WATERING OPTIONS

COMPETITOR CHANGEOVER & REPLACEMENT ITEMS		SHIP WEIGHT		LIST PRICE
		LBS.	KG.	
CATALOG #	ITEM DESCRIPTION			
VZA150	Val Ziggity Saddle Kit Note: This kit includes a replacement adapter (with new O-ring) to replace the Ziggity twin style drinker. This adapter will accept any Val standard J-lock drinker. This retro-fit saddle locks into the Ziggity twin lock saddle, then the Val J-lock can be installed into the adapter. With this kit there is no need to replace the pipe or suspension/winching hardware. The Drinker is not included and must be ordered separately.	0.01	0.00	
820056	Val Ziggity Adapter Seal Note: Replacement seal for Val Ziggity Saddle Kit	0.00	0.00	
VS205	Glued Saddle for Small Square Pipe - For Threaded Drinker - 1/4" (6.35mm) Stem	0.01	0.01	
VS205L	Glued Saddle for Small Square Pipe - For Threaded Drinker - 11/32" (8.73mm) Stem	0.01	0.00	
VS405	Glued Saddle for Large Square Pipe - For Threaded Drinker - 1/4" (6.35mm) Stem	0.01	0.00	
VS405L	Glued Saddle for Large Square Pipe - For Threaded Drinker - 11/32" (8-73mm) Stem	0.01	0.00	
	<i>Note: VS205L & VS405L are replacement saddles for square pipe that previously had threaded drinkers; the stem is slightly larger than the standard glued saddle so it can be glued into the existing threaded hole.</i>			
VL150THD	Layer Drinker - Threaded Note: This drinker is a replacement for Lubing or any European style threaded drinker. The internal components of this drinker are the same as a standard Val Drinker. An advantage of this drinker is that after the drinker has been threaded into the pipe the internal components can be removed from the drinker without removing the unit from the pipe.	0.02	0.01	
VR150THD	Roaster Drinker Threaded	0.02	0.01	
VR150PFATHD	PFA Drinker Threaded	0.03	0.01	
VR150ZS	Roaster Drinker with Ziggity Short Plug	0.02	0.01	

Minimum Order of 2000 Drinkers. Use QE- Numbers for order quantities less then 2000 Drinkers

LAYER WATERING OPTIONS

PVC PIPE & CONNECTORS

NOTE: Call for order info, pricing and availability of pipe only (PVC pipe with glued saddles)

CATALOG #	ITEM DESCRIPTION	SHIP WEIGHT		LIST PRICE
		LBS.	KG.	
VC100	PVC Pipe Cutter (1 1/4" Max Diameter)	1.05	0.48	
730415	PVC Cement Glue (1/2 Pint)	1.00	0.45	
VG124	PVC Cement Glue (Pint)	1.14	0.52	
VG125-QT	PVC Cement Glue (Quart)	2.00	0.91	
VC210	PVC Cleaner (1/2 Pint)	0.55	0.25	
VP001	10' X 3/4" Plain PVC Pipe	1.20	0.54	
VP008	8' X 3/4" Plain PVC Pipe	0.93	0.42	
VC145	3/4" Coupler W/ O-Ring	0.06	0.03	
VS146	Standard Saddle	0.01	0.00	
VS146-Q500	Standard Saddle - Box of 500	5.60	2.54	
VL145	45 Degree Saddle - Open Face	0.02	0.01	
VL155	45 Degree Saddle - Closed Face	0.02	0.01	
VP001SQ	10' .875" Small Square PVC Pipe	1.92	0.87	
VC143	Square-to-Round Connector (small square pipe)	0.02	0.01	
820271	Square-to-Square Flex Connector Assembly (small square pipe)	0.06	0.03	
VS205	Saddle for Small Square Pipe - 1/4" (6.3mm) Stem	0.01	0.01	
VS205L	Saddle for Small Square Pipe (Threaded Drinker) - 11/32" (8.7mm) Stem	0.01	0.00	
VP002SQ	10' x 1.1" Large Square PVC Pipe	1.81	0.82	
VC243	Square-to-Round Connector (large square pipe)	0.02	0.01	
820270	Square-to-Square Flex Connector Assembly (Large square pipe)	0.07	0.03	
VS405	Saddle for Large Square Pipe - 1/4" (6.3mm) Stem	0.01	0.00	
VS405L	Saddle for Large Square Pipe (Threaded Drinker)- 11/32" (8.7mm) Stem	0.01	0.00	
VT194	1 1/2" PVC Pipe (10')	3.35	1.52	

PVC FITTINGS

VC146	3/4" PVC Coupling SXS	0.30	0.14	
VC148	3/4" PVC Cross SXSXSXS	0.01	0.00	
VC400	3/4" PVC Cap	0.04	0.02	
VT100	3/4" PVC Tee SXSXS	0.01	0.00	
VT101	3/4" PVC Tee SXSX 1/2" Thread	0.09	0.04	
VT102	3/4" PVC 90 Ell SXS	0.07	0.03	
VT106	3/4" Female Slip X 1/2" FPT PVC Reducer	0.05	0.02	
VT107	3/4" Male Slip X 1/2" FPT Bushing	0.03	0.01	
VT130	3/4" PVC Tee SXSX Thread	0.01	0.00	
VT131	3/4" PVC Male Adapter SX Thread	0.04	0.02	
VT132	3/4" PVC Female Adapter SX Thread	0.05	0.02	
VT133	3/4" PVC 90 ELL SX Thread	0.04	0.02	
VT134	3/4" PVC 90 ELL SX 1/2" Thread	0.07	0.03	
VT135	3/4" PVC 90 Degree ELL SX 1/2" S	0.01	0.00	
VT141	1" PVC Male Adapter Thread X 3/4" S	0.01	0.00	
VT188	1/2" PVC Male Adapter 1/2" Slip X 1/2" Thread	0.03	0.02	
VT189	3/4" PVC Bushing SX 1/2" S Reducer	0.02	0.01	
VT190	1/2" PVC Tee SXSXS	0.00	0.00	
VT191	1/2" Coupling SXS	0.03	0.01	
VT192	1/2" PVC 90N ELL SXS	1.42	0.64	
VT195	1 1/2" X 3/4" Bushing SXS	0.12	0.05	
VT196	1 1/2" PVC Cross DWV Fitting	7.16	3.25	
VT197	1/2" Union SXS	0.01	0.00	
VT198	1 1/2" PVC Coupler	0.16	0.07	
VT199	1 1/2" PVC Tee	0.16	0.07	
VT200	1 1/2" 90 Degree PVC ELL	0.28	0.13	
VT201	3/4" X 3/4" X 1/2" Tee SXSXS	0.10	0.05	
VT202	Bushing 1-1/2" X 1/2" THD.	0.10	0.04	
VT203	Bushing 1-1/2" X 1/2" S	0.00	0.00	
VT204	Socket 1-1/2" X 1-1/2" Barbed	0.14	0.06	
VT205	PVC Tube Plug	0.03	0.01	
VX127	3/4" UNION S X S	0.16	0.07	

VR-201 V-MAX REGULATOR

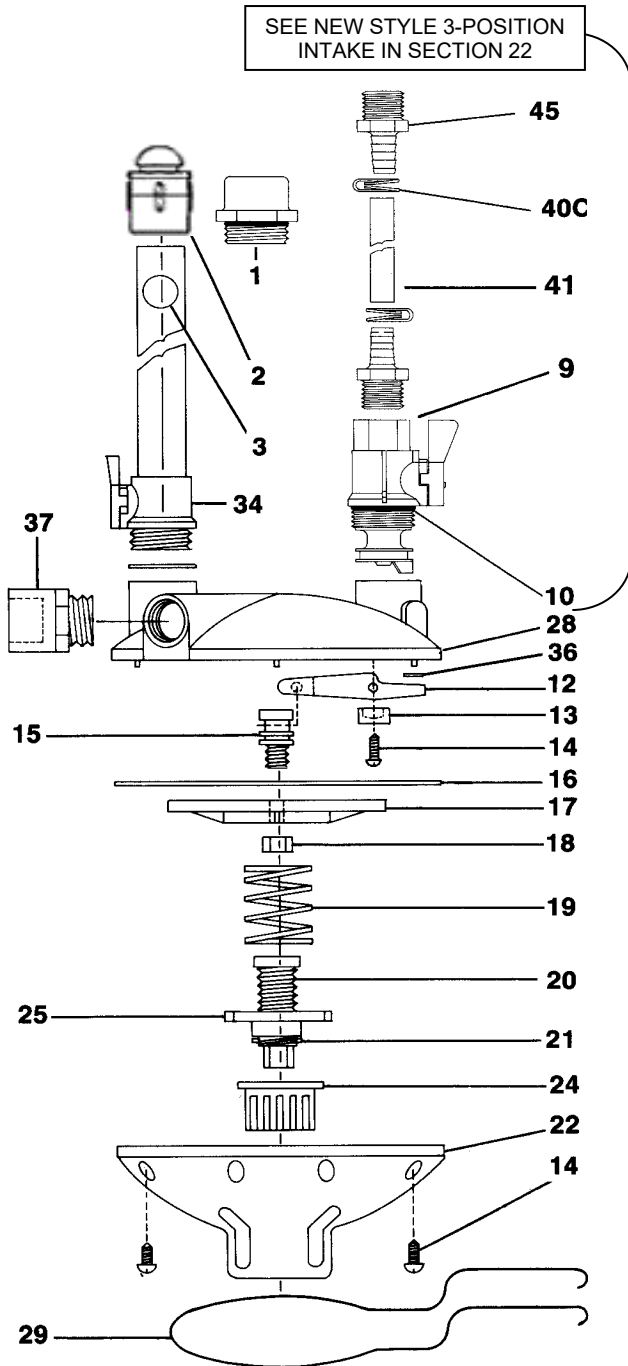

KEY	PART #	DESCRIPTION
1	VRP38	Regulator Plug
2	820611	Rigid TruSeal
3	VRP03	Standpipe Ball
9	VRP09	1/2" NPT Intake With Shutoff
	VRP09L	Low Pressure 1/2" NPT Intake W/Shutoff
10	VO145	O-Ring (Coupler)
12	VRP12G	Pivot
13	VRP13	Pivot Screw (2)
14	VRP14	Screw - Pivot Brkt (2) - Housing (9)
15	VRP15	Diaphragm Bolt
16	VRP16	Diaphragm
17	VRP52	Diaphragm Plate
18	VRP18	Diaphragm Nut
19	VRP19	Spring
20	VRP20	Adjustment Bolt
21	VRP21	Adjustment Bolt Pin
22	VRP22	Bottom Housing
24	VRP24	Adjustment Knob
25	VRP25	Adjustment collar
28	VRP28	Top Housing
29	VRP29	Optional Mounting Bracket
34		Standpipe (see page 24-04)
36	VRP36G	Seal
37	VT131	3/4" Male Adapter
40	VF204C	3/8" Hose Clamp
41	VRP48	PVC Yellow Reinforced Hose 3/8" 200 PSI
45	VRP45	1/2" Threaded Male Barb Hose Connector

VR-204 V-MAX REGULATOR

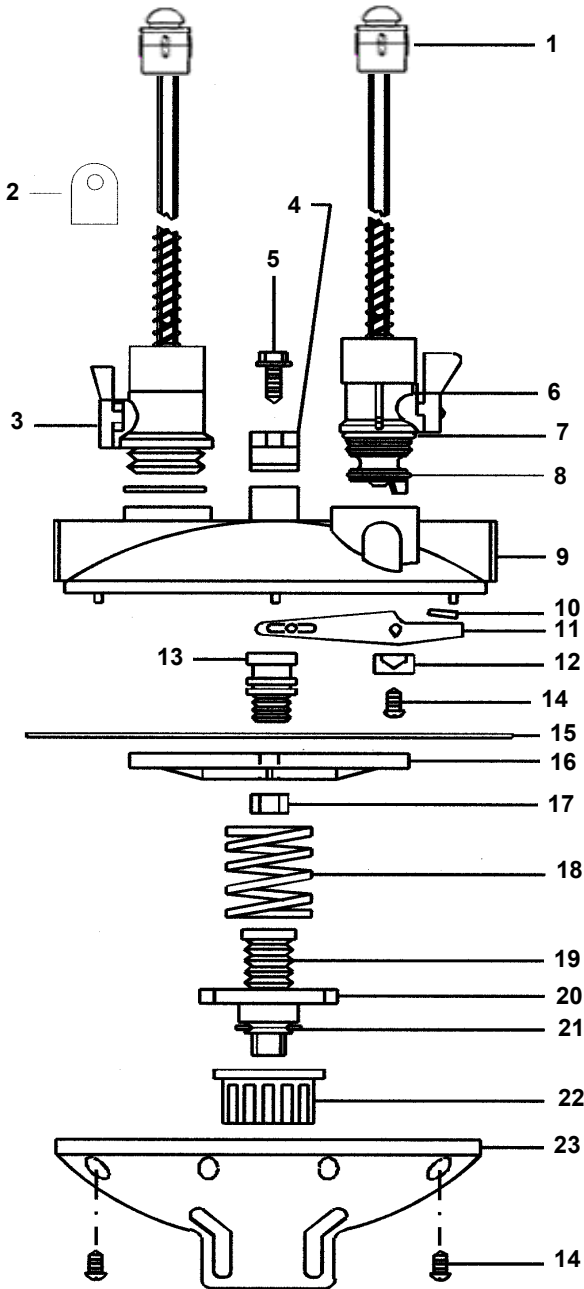

KEY	PART #	DESCRIPTION
1	820295	TruSeal Cap for Flex Standpipe
2	VRP42	(2) Mounting Brackets for Aluminum Extrusion
3		Standpipe - See page 22-04
4	VRP06	Pipe Clamp
5	VRP05-1	Screws for Pipe Clamp & Filter Bracket
6		Standpipe - See page 22-04
7	VO145	O-Ring for 3/4" Couplings
8	VRP31	O-Ring Seal
9	VRP32	Top Housing
10	VRP36G	Rubber Wafer Replacement
11	VRP12G	Pivot
12	VRP13	Pivot Brackets (Multiples of 2)
13	VRP15	Diaphragm Bolt
14	VRP14	Screw - 2 for Pivot Bracket or 9 for Bottom Housing
15	VRP16	Diaphragm
16	VRP52	Diaphragm Plate
17	VRP18	Diaphragm Nut
18	VRP19	Spring
19	VRP20	Adjustment Bolt
20	VRP25	Adjustment Collar
21	VRP21	Adjustment Bolt Pin
22	VRP24	Adjustment Knob
23	VRP22	Bottom Housing

VR-205 V-MAX REGULATOR

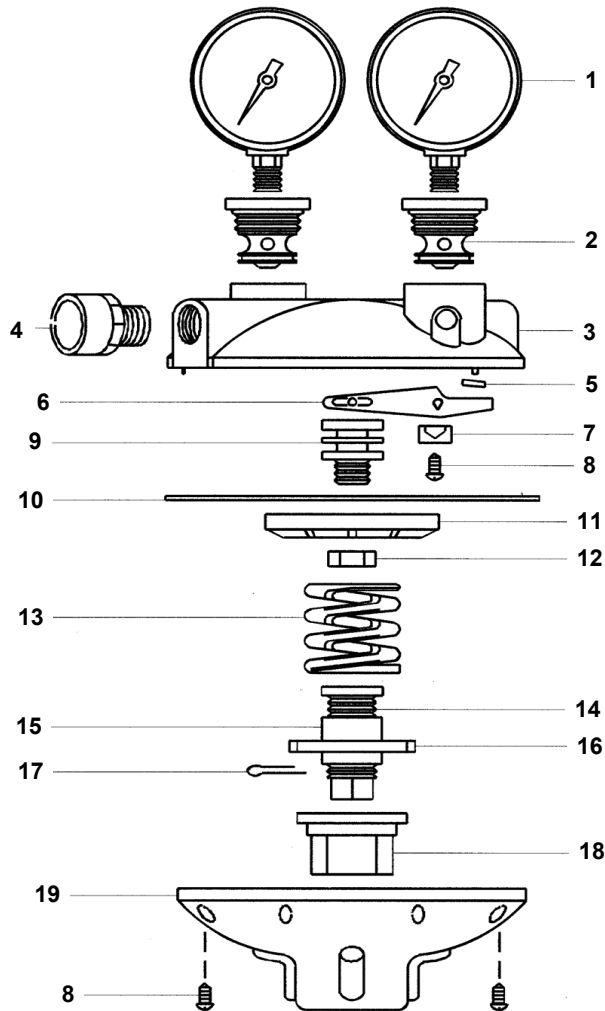

KEY	PART #	
1	VG100	Oil Filled Pressure Gauge (0-100 PSI)
2	VRP57	Gauge Intake
3	VRP58	Top Housing
4	VT131	3/4" PVC Male Adapter SX thread
5	VRP36G	Rubber Wafer Replacement
6	VRP12G	Pivot - New Style
7	VRP13	Pivot Brackets
8	VRP14	Screw - 2 for Pivot Bracket or 9 for Bottom Housing
9	VRP15	Diaphragm Bolt
10	VRP51	Diaphragm
11	VRP52	Diaphragm Plate
12	VRP18	Diaphragm Nut
13	VRP53	Spring
14	VRP20	Adjustment Bolt Pin
15	VRP50	Diaphragm Spacer
	820224	Diaphragm 1/2 Spacer
16	VRP25	Adjustment Collar
17	VRP21	Adjustment Bolt Pin
18	VRP55	Adjustment Knob
19	VRP54	Bottom Housing

VR209 REGULATOR REPAIRS

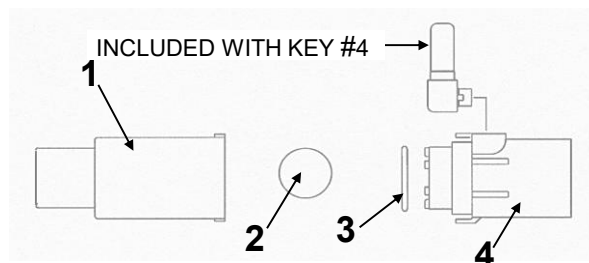

KEY	PART #	ITEM DESCRIPTION	List Price
1	VRP90	Left Housing with Stainless Steel Seat (SS Ball NOT Included) <i>Note: This part may be used in place of Left Housing & Plunger on VR208 Regulator to convert to New Style VR209 Regulator.</i>	
2	VRP94	Stainless Steel Ball Only - 18mm 440CSS, Grade 25	
3	VO145	O-Ring for 3/4" Couplings	
4	VRP78	Right Housing with O-ring	



REGULATOR REPAIRS

NUMERICAL LIST OF REGULATOR REPAIRS		SHIP WEIGHT		LIST PRICE
CATALOG #	ITEM DESCRIPTION	LBS.	KGS.	
820295	Auto Shutoff Cap for Flex Standpipe	0.05	0.02	
820611	Auto Shutoff Cap for Rigid Standpipe	0.06	0.03	
820334	Auto Shutoff Cap Replacement Seal for Flex Standpipe	0.00	0.00	
820335	Auto Shutoff Cap Replacement Seal for Rigid Standpipe	0.00	0.00	
PMHC3/4	3/4" Hose Clamp (2 req'd)	0.04	0.01	
PMTT6	7.5" Wire Tie	0.00	0.01	
RFV150	Flushing Intake Housing	0.18	0.08	
RFV151	Flushing Intake Cap	0.05	0.02	
RFV152	Flushing Intake Handle	0.04	0.02	
RFV153L	Flushing Intake Shaft Low Pressure	0.12	0.05	
RFV153S	Flushing Intake Shaft High Pressure	0.12	0.05	
RFV154	(2) Large O-Ring for RFV153	0.00	0.00	
RFV155	(2) Small O-Ring for RFV153	0.00	0.00	
RFV160	3-Position Intake	0.41	0.18	
RFV160L	3-Position Intake (Low Pressure)	0.41	0.18	
VF204C	Hose Clamp for 3/8" Urethane	0.01	0.01	
VG100	Oil Filled Pressure Gauge (0-100 PSI)	0.50	0.23	
VO145	O-Ring for 3/4" Couplings	0.00	0.00	
VO145S	O-Ring for RFV150	0.00	0.00	
VR202RK	Rebuild Kit for VR 202	1.17	0.53	
VRP03	5/8" Blue Rigid Standpipe Ball	0.01	0.00	
VRP03F	5/16 Blue Flex Standpipe Ball	0.00	0.00	
VRP05-1	Screws for Pipe Clamp & Filter Bracket	0.01	0.00	
VRP06	Pipe Clamp	0.06	0.03	
VRP09	1/2" NPT Intake With Shutoff	0.13	0.06	
VRP09L	1/2" NPT Low Press Intake With S/O	0.09	0.04	
VRP11	Top Housing - VR202 Regulator	0.50	0.23	
VRP119	O-Ring for Bottom of RVH114	0.00	0.00	
VRP12G	Pivot - New Style	0.03	0.01	
VRP13	Pivot Brackets (Multiples of 2)	0.00	0.00	
VRP14	Screw - 2 for Bracket or 9 for Bottom Housing	0.00	0.00	
VRP15	Diaphragm Bolt	0.02	0.01	
VRP16	Diaphragm	0.12	0.06	
VRP18	Diaphragm Nut	0.03	0.01	
VRP19	Spring	0.05	0.02	
VRP20	Adjustment Bolt Pin	0.03	0.01	
VRP21	Adjustment Bolt Pin	0.00	0.00	
VRP22	Bottom Housing	0.47	0.21	
VRP23	Top Housing - VR203 Regulator	0.60	0.27	
VRP24	Adjustment Knob	0.07	0.03	
VRP25	Adjustment Collar	0.03	0.01	

LISTING CONTINUED ON NEXT PAGE

REGULATOR REPAIRS

NUMERICAL LIST OF REGULATOR REPAIRS		SHIP WEIGHT		LIST PRICE
		LBS.	KGS.	
CATALOG #	ITEM DESCRIPTION			
VRP28	Top Housing - VR201 Regulator	0.54	0.25	
VRP29	Regulator Mounting Bracket to Cage	0.39	0.18	
VRP30F	Intake With Shutoff (Flex)	0.12	0.05	
VRP31	O-Ring Seal - .867" ID	0.00	0.00	
VRP32	Top Housing - VR204 Regulator	0.55	0.25	
VRP38	Regulator Plug	0.04	0.02	
VRP36G	Rubber Wafer Replacement	0.00	0.00	
VRP42	Set of 2 Mounting Brackets for Aluminum Extrusion	0.01	0.00	
VRP45	1/2" Threaded Male Hose Connector (3/8" Barb)	0.01	0.00	
VRP48	PVC Yellow Reinforced Hose 3/8" 200 PSI (Drop Hose)	0.08	0.04	
VRP50	Diaphragm Spacer	0.01	0.01	
VRP51	Diaphragm	0.15	0.07	
VRP52	Diaphragm Plate	0.09	0.04	
VRP53	Spring	0.31	0.14	
VRP54	Bottom Housing	0.45	0.20	
VRP55	Adjustment Knob	0.07	0.03	
VRP57	Gauge Intake	0.04	0.02	
VRP58	Top Housing - VR205 Regulator	0.53	0.24	
VRP66	3/4" Barbed x 1/2" Male NPT Straight Fitting	0.04	0.02	
VRP67	3/4" Barbed Elbow x Female 3/4" NPT	0.06	0.03	
VRP67S	3/4" Barb x Female 3/4" NPT	0.05	0.02	
VRP68	3/4" Barbed Y Connector	0.05	0.02	
VRP76	3/4" Close Nipple Plastic	0.03	0.01	
VRP79	3/4" ID Yellow Hose - Per Foot	0.18	0.08	
VRP90	Left Housing With Stainless Steel Ball	0.11	0.05	
VRP94	Stainless Steel Ball Only - 18MM 440CSS, Grade 25	0.05	0.02	
VS130	Spring for 18" Flex Standpipe	0.17	0.07	
VS132	Spring for 24" Flex Standpipes	0.23	0.10	
VS133	Spring for 30" Flex Standpipes	0.28	0.13	
VS134	Spring for 36" Flex Standpipes	0.34	0.15	
VSC250	Body Only for VC025	0.00	0.00	
VSC251	Cap Only for VC025	0.00	0.00	
820335	Seal for VC025	0.00	0.00	
VSC750	Body Only for VC075	0.01	0.00	
VSC751	Cap Only for VC075	0.01	0.01	
820334	Seal for VC075	0.00	0.00	
VT131	3/4" PVC Male Adapter SX Thread	0.04	0.02	

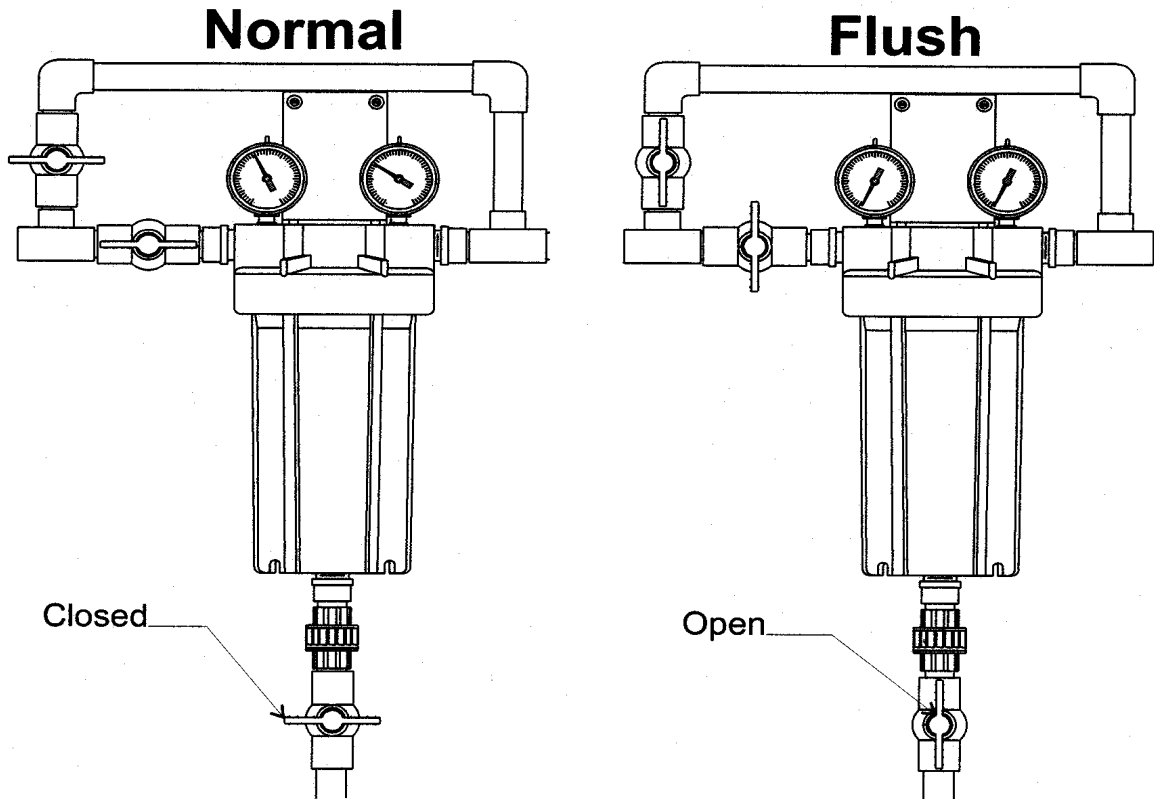

CATALOG NUMBER	ITEM DESCRIPTION	LIST PRICE
VF123	Bottom Housing for VF121 and VF122	
VF125	O-Ring for VF120 Filter Kit	
VF126	O-Ring for VF121 and VF122 Filter Kit	
VF128	Filter Bracket (Aluminum)	
VF129	Lid for Filter	
VG100	Oil Filled Pressure Gauge (0-100 PSI)	
VG100L	Oil Filled Pressure Gauge (0-15 PSI)	
VM121-10	Reusable Filter Cartridge for VF121/VF122 (10 Micron) - Blue Dot	
VM121-30	Reusable Filter Cartridge for VF121/VF122 (30 Micron) - Black Dot	
VM121-50	Reusable Filter Cartridge for VF121/VF122 (50 Micron) - Red Dot	
VT131	3/4" PVC Male Adapter S X Thread	
VT141	1" PVC Male Adapter 1" Thread X 3/4" S	
VX127	3/4" Union S X S	